



First Edition  
February 2024

**Copyright © 2024 ASUSTeK COMPUTER INC. All Rights Reserved.**

No part of this manual, including the products and software described in it, may be reproduced, transmitted, transcribed, stored in a retrieval system, or translated into any language in any form or by any means, except documentation kept by the purchaser for backup purposes, without the express written permission of ASUSTeK COMPUTER INC. ("ASUS").

Product warranty or service will not be extended if: (1) the product is repaired, modified or altered, unless such repair, modification or alteration is authorized in writing by ASUS; or (2) the serial number of the product is defaced or missing.

ASUS PROVIDES THIS MANUAL "AS IS" WITHOUT WARRANTY OF ANY KIND, EITHER EXPRESS OR IMPLIED, INCLUDING BUT NOT LIMITED TO THE IMPLIED WARRANTIES OR CONDITIONS OF MERCHANTABILITY OR FITNESS FOR A PARTICULAR PURPOSE. IN NO EVENT SHALL ASUS, ITS DIRECTORS, OFFICERS, EMPLOYEES OR AGENTS BE LIABLE FOR ANY INDIRECT, SPECIAL, INCIDENTAL, OR CONSEQUENTIAL DAMAGES (INCLUDING DAMAGES FOR LOSS OF PROFITS, LOSS OF BUSINESS, LOSS OF USE OR DATA, INTERRUPTION OF BUSINESS AND THE LIKE), EVEN IF ASUS HAS BEEN ADVISED OF THE POSSIBILITY OF SUCH DAMAGES ARISING FROM ANY DEFECT OR ERROR IN THIS MANUAL OR PRODUCT.

SPECIFICATIONS AND INFORMATION CONTAINED IN THIS MANUAL ARE FURNISHED FOR INFORMATIONAL USE ONLY, AND ARE SUBJECT TO CHANGE AT ANY TIME WITHOUT NOTICE, AND SHOULD NOT BE CONSTRUED AS A COMMITMENT BY ASUS. ASUS ASSUMES NO RESPONSIBILITY OR LIABILITY FOR ANY ERRORS OR INACCURACIES THAT MAY APPEAR IN THIS MANUAL, INCLUDING THE PRODUCTS AND SOFTWARE DESCRIBED IN IT.

Products and corporate names appearing in this manual may or may not be registered trademarks or copyrights of their respective companies, and are used only for identification or explanation and to the owners' benefit, without intent to infringe.

# Contents

Contents .....	iii
Notices.....	iv
Safety information .....	v
Care & Cleaning .....	vii
Takeback Services.....	viii
Product information for EU energy label.....	viii
<b>Chapter 1: Product introduction</b>	
1.1 Welcome! .....	1-1
1.2 Package contents.....	1-1
1.3 Monitor introduction .....	1-2
1.3.1 Front view .....	1-2
1.3.2 Back view .....	1-3
1.3.3 GamePlus function.....	1-4
1.3.4 GameVisual function.....	1-6
1.3.5 Other Function(s) .....	1-7
<b>Chapter 2: Setup</b>	
2.1 Attaching the arm/base .....	2-1
2.2 Cable management .....	2-2
2.3 Detaching the arm/base (for VESA .wall mount).....	2-2
2.4 Adjusting the monitor.....	2-3
2.5 Connecting the cables.....	2-4
2.6 Turning on/off the monitor .....	2-5
<b>Chapter 3: General instructions</b>	
3.1 OSD (On-Screen Display) menu .....	3-1
3.1.1 How to reconfigure.....	3-1
3.1.2 OSD function introduction .....	3-2
3.2 Aura .....	3-12
3.3 Specifications summary.....	3-13
3.4 Outline dimensions.....	3-15
3.5 Troubleshooting (FAQ).....	3-16
3.6 Supported operating modes .....	3-17

# Notices

## Federal Communications Commission Statement

This device complies with Part 15 of the FCC Rules. Operation is subject to the following two conditions:

- This device may not cause harmful interference, and
- This device must accept any interference received including interference that may cause undesired operation.

This equipment has been tested and found to comply with the limits for a Class B digital device, pursuant to Part 15 of the FCC Rules. These limits are designed to provide reasonable protection against harmful interference in a residential installation. This equipment generates, uses and can radiate radio frequency energy and, if not installed and used in accordance with the instructions, may cause harmful interference to radio communications. However, there is no guarantee that interference will not occur in a particular installation. If this equipment does cause harmful interference to radio or television reception, which can be determined by turning the equipment off and on, the user is encouraged to try to correct the interference by one or more of the following measures:

- Reorient or relocate the receiving antenna.
- Increase the separation between the equipment and receiver.
- Connect the equipment into an outlet on a circuit different from that to which the receiver is connected.
- Consult the dealer or an experienced radio/TV technician for help.



---

The use of shielded cables for connection of the monitor to the graphics card is required to assure compliance with FCC regulations. Changes or modifications to this unit not expressly approved by the party responsible for compliance could void the user's authority to operate this equipment.

---

## Canadian Department of Communications Statement

This digital apparatus does not exceed the Class B limits for radio noise emissions from digital apparatus set out in the Radio Interference Regulations of the Canadian Department of Communications.

This class B digital apparatus complies with Canadian ICES-003.

This Class B digital apparatus meets all requirements of the Canadian Interference - Causing Equipment Regulations.

Cet appareil numérique de la classe B respecte toutes les exigences du Règlement sur le matériel brouilleur du Canada.



# Safety information

- Before setting up the monitor, carefully read all the documentation that came with the package.
- To prevent fire or shock hazard, never expose the monitor to rain or moisture.
- Never try to open the monitor cabinet. The dangerous high voltages inside the monitor may result in serious physical injury.
- If the power supply is broken, do not try to fix it by yourself. Contact a qualified service technician or your retailer.
- Before using the product, make sure all cables are correctly connected and the power cables are not damaged. If you detect any damage, contact your dealer immediately.
- Slots and openings on the back or top of the cabinet are provided for ventilation. Do not block these slots. Never place this product near or over a radiator or heat source unless proper ventilation is provided.
- The monitor should be operated only from the type of power source indicated on the label. If you are not sure of the type of power supply to your home, consult your dealer or local power company.
- Use the appropriate power plug which complies with your local power standard.
- Do not overload power strips and extension cords. Overloading can result in fire or electric shock.
- Avoid dust, humidity, and temperature extremes. Do not place the monitor in any area where it may become wet. Place the monitor on a stable surface.
- Unplug the unit during a lightning storm or if it will not be used for a long period of time. This will protect the monitor from damage due to power surges.
- Never push objects or spill liquid of any kind into the slots on the monitor cabinet.
- To ensure satisfactory operation, use the monitor only with UL listed computers which have appropriate configured receptacles marked between 100-240V AC.
- If you encounter technical problems with the monitor, contact a qualified service technician or your retailer.
- Adjustment of the volume control as well as the equalizer to other settings than the center position may increase the ear-/headphones output voltage and therefore the sound pressure level.
- The adapter is only used for this monitor, do not use it for other purpose. Your device uses one of the following power supplies:
  - Manufacturer: Delta Electronics Inc., Model: ADP-280BB B, ADP-280EB F
- Ensure to connect the power cord to a socket-outlet with earthing connection.
- The supplied power adapter and/or power cable are designed to use with the product only. Do not use with other products.



This symbol of the crossed out wheeled bin indicates that the product (electrical, electronic equipment, and mercury-containing button cell battery) should not be placed in municipal waste. Please check local regulations for disposal of electronic products.

## Prevent Tipping

When using the display, fasten the monitor to a wall using a cord or chain that can support the weight of the monitor in order to prevent the monitor from falling.

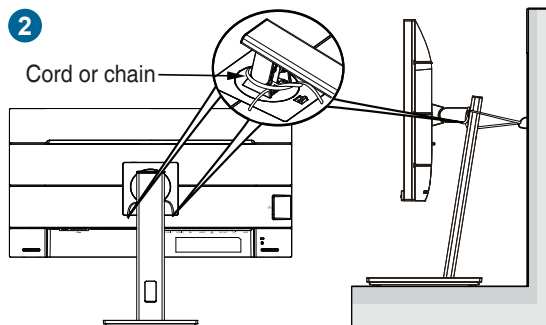
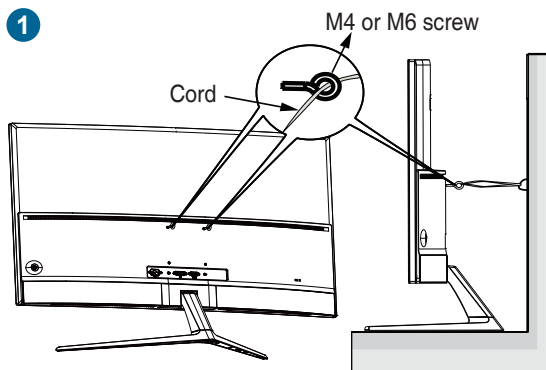



- Display design may differ from those illustrated.
- Installing must be done by a qualified technician, and please contact your supplier for more information.
- For the models with net weight  $\geq 7$ kg. Please select the suitable way to prevent tipping.
- For the models with VESA mount, please use method **1**, install the screws with ring to the VESA mount hole, then tie the cord or chain to the wall. Otherwise, please use method **2** to tie the cord or chain to the stand and then fix it to the wall.

## **AEEE yönetmeliğine uygundur**

## **Care & Cleaning**

- Before you lift or reposition your monitor, it is better to disconnect the cables and power cord. Follow the correct lifting techniques when positioning the monitor. When lifting or carrying the monitor, grasp the edges of the monitor. Do not lift the display by the stand or the cord.
- Cleaning. Turn your monitor off and unplug the power cord. Clean the monitor surface with a lint-free, non-abrasive cloth. Stubborn stains may be removed with a cloth dampened with mild cleaner.
- Avoid using a cleaner containing alcohol or acetone. Use a cleaner intended for use with the monitor. Never spray cleaner directly on the screen, as it may drip inside the monitor and cause an electric shock.

### **The following symptoms are normal with the monitor:**

- You may find slightly uneven brightness on the screen depending on the desktop pattern you use.
- When the same image is displayed for hours, an afterimage of the previous screen may remain after switching the image. The screen will recover slowly or you can turn off the Power Switch for hours.
- When the screen becomes black or flashes, or cannot work anymore, contact your dealer or service center to fix it. Do not repair the screen by yourself!

## Conventions used in this guide



**WARNING:** Information to prevent injury to yourself when trying to complete a task.



**CAUTION:** Information to prevent damage to the components when trying to complete a task.



**IMPORTANT:** Information that you **MUST** follow to complete a task.



**NOTE:** Tips and additional information to aid in completing a task.

## Where to find more information

Refer to the following sources for additional information and for product and software updates.

### 1. ASUS websites

The ASUS websites worldwide provide updated information on ASUS hardware and software products. Refer to <http://www.asus.com>

### 2. Optional documentation

Your product package may include optional documentation that may have been added by your dealer. These documents are not part of the standard package.

### 3. About Flicker

[https://www.asus.com/Microsite/display/eye\\_care\\_technology/](https://www.asus.com/Microsite/display/eye_care_technology/)

## Takeback Services

ASUS recycling and takeback programs come from our commitment to the highest standards for protecting our environment. We believe in providing solutions for our customers to be able to responsibly recycle our products, batteries and other components as well as the packaging materials.

Please go to <http://csr.asus.com/english/Takeback.htm> for detail recycling information in different region.

## Product information for EU energy label



PG32UCDM



## 1.1 Welcome!

Thank you for purchasing the ASUS® OLED monitor!

The latest widescreen OLED monitor from ASUS provides a broader, brighter and crystal-clear display, plus a host of features that enhance your viewing experience.

With these features, you can enjoy the convenience and delightful visual experience that the monitor brings to you!

## 1.2 Package contents

Check your package for the following items:

- ✓ OLED monitor
- ✓ Monitor base
- ✓ Quick start guide
- ✓ Warranty card
- ✓ Power adapter
- ✓ Power cord
- ✓ HDMI cable (optional)
- ✓ DisplayPort cable (optional)
- ✓ USB Type-A to Type-B cable (optional)
- ✓ USB Type-C cable (optional)
- ✓ ROG welcome card with envelope
- ✓ ROG Wall mount kit
- ✓ ROG sticker
- ✓ ROG pouch



---

If any of the above items is damaged or missing, contact your retailer immediately.

---



---

If you need to replace the power cord or the connection cable(s), please contact ASUS customer service.

---

# 1.3 Monitor introduction

## 1.3.1 Front view

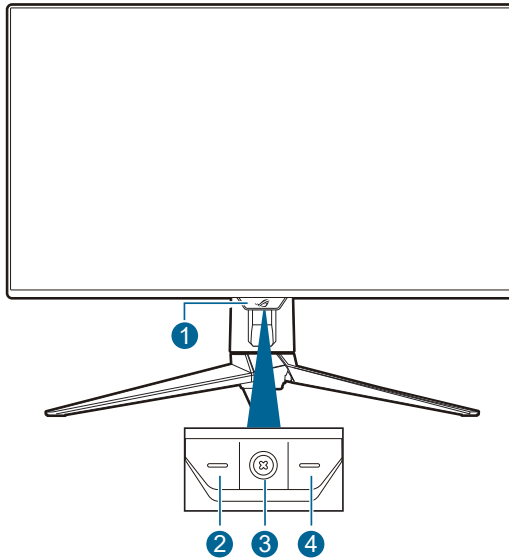

### 1. Power indicator

- The color definition of the power indicator is as the below table.

Status	Description
Red	ON
OFF	OFF
Amber	Standby mode/No signal
Orange flashing	Pixel cleaning

### 2. Close button

- Turns on the monitor when the monitor enters standby mode or displays the “NO SIGNAL” message.
- Press to activate the Input Select hotkey. To change the hotkey function, go to the **MyFavorite > Shortcut > ** menu.
- Press this button to exit the OSD menu when the OSD menu is activated.

### 3. Navigation (5-way) button:

- Turns on the monitor when the monitor enters standby mode or displays the “NO SIGNAL” message.

- Press this button to activate the OSD menu. In the OSD menu, press this button to enter the OSD menu or enact the selected OSD menu items. Move the button up/down/right/left to navigate through the settings, increases/decreases values or moves your selection up/down/left/right.
  - Move and hold the button downward for over 5 seconds to enable/disable the Key Lock function.
  - Move the button right to activate the GamePlus hotkey. To change the hotkey function, go to the **MyFavorite > Shortcut >** menu.
  - Move the button up to activate the GameVisual hotkey. To change the hotkey function, go to the **MyFavorite > Shortcut >** menu.
  - Move the button down to activate the Pixel Cleaning hotkey. To change the hotkey function, go to the **MyFavorite > Shortcut >** menu.
4.  Power button
- Turns the monitor on/off.

### 1.3.2 Back view

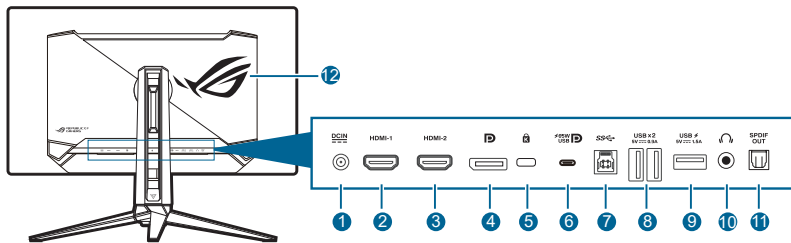

1. **DC-IN port.** This port connects the power cord.
2. **HDMI-1 port.** This port is for connection with an HDMI compatible device.
3. **HDMI-2 port.** This port is for connection with an HDMI compatible device.
4. **DisplayPort.** This port is for connection with a DisplayPort compatible device.
5. **Kensington lock slot.**
6. **USB 3.2 Gen 1 Type-C (supports DP Alt mode).** This port is for connection with a DisplayPort/USB Type-C compatible device. This port is also for connection with a USB upstream cable, which supports USB power and data delivery (depending on the signal source).







The port offers output voltage 5V/3A, 9V/3A, 12V/3A, 15V/3A and 20V/3.25A for 65W power delivery and 5V/3A, 9V/3A, 12V/3A, 15V/3A and 20V/4.5A for 90W power delivery. Connecting the USB Type-C to Type-A cable only enables the USB Type-A ports (downstream) on the monitor.

7. **USB 3.2 Gen 1 Type-B.** This port is for connection with a USB upstream cable. The connection enables the USB ports on the monitor.
8. **USB 3.2 Gen 1 Type-A.** These ports are for connection with USB devices, such as USB keyboard/mouse, USB flash drive, etc.
9. **USB 3.2 Gen 1 Type-A.** This port is for connection with USB devices, such as USB keyboard/mouse, USB flash drive, etc.
10. **Earphone jack.** This port is only available when an HDMI/DisplayPort/USB Type-C cable is connected.
11. **SPDIF out (Optical Digital Audio Out).** This output port is for connection with a device that includes an SPDIF input.
12. **AURA RGB/AURA Sync (controlled by Armoury Crate software).**

### 1.3.3 GamePlus function

The GamePlus function provides a toolkit and creates a better gaming environment for users when playing different types of games. The crosshair overlay with 6 different crosshair options lets you choose the one that best suits the game you're playing. There are also on screen timer and stopwatch you can position on the left of the display so you can keep track of the gaming time; while the FPS (frames per second) counter lets you know how smooth the game is running. The position of FPS Counter, Crosshair, Timer and Stopwatch can be moved by the navigation (5-way) button. Sniper function (only available when HDR is disabled on your device)) is customized for first-person shooters. You can select the magnification ratio, the type of alignment in sequence and night vision mode. Display Alignment displays alignment lines on 4 sides of the screen, serving as an easy and handy tool for you to line up multiple monitors perfectly.

To activate GamePlus:



1. Press the GamePlus shortcut button
2. Move the  (5-way) button up/down to select among different functions.
3. Press the  (5-way) button to activate the function you choose, or display the settings.
4. Move the  (5-way) button up/down to navigate through the settings. Highlight the desired setting and press the  (5-way) button to activate it.
5. Press the  Close button to exit.

<p><b>GamePlus Main Menu</b></p> 	<p><b>GamePlus — FPS Counter</b></p> 
<p><b>GamePlus — Crosshair</b></p> 	<p><b>GamePlus — Sniper/Sniper Night Vision</b></p> 
<p><b>GamePlus — Timer</b></p> 	

### 1.3.4 GameVisual function

The GameVisual function helps you select among different picture modes in a convenient way.

To activate GameVisual:

1. Press the GameVisual shortcut button
2. Move the  (5-way) button up/down to highlight a desired setting.
3. Press the  (5-way) button to activate it.
4. Move the  (5-way) button left to go back, or press the **X** Close button to exit.
  - **Scenery Mode:** This is the best choice for scenery photo displaying with GameVisual™ Video intelligence Technology.
  - **Racing Mode:** This is the best choice for racing game playing with GameVisual™ Video intelligence Technology.
  - **Cinema Mode:** This is the best choice for movie watching with GameVisual™ Video intelligence Technology.
  - **RTS/RPG Mode:** This is the best choice for Real-Time Strategy (RTS)/ Role-Playing Game (RPG) playing with GameVisual™ Video intelligence Technology.
  - **FPS Mode:** This is the best choice for First Person Shooter game playing with GameVisual™ Video intelligence Technology.
  - **sRGB Cal Mode:** This is the best choice for viewing photos and graphics from PCs.
  - **MOBA Mode:** This is the best choice for multiplayer online battle arena game playing with GameVisual™ Video intelligence Technology.
  - **Night Vision:** This is the best choice for dark scenery playing with GameVisual™ Video intelligence Technology.
  - **User Mode:** More items are adjustable for color adjustments.



- 
- In the **sRGB Cal** mode, the following function(s) are not user-configurable: **Shadow Boost, Uniform Brightness, Contrast, Blue Light Filter, Display Color Space, Color Temp., Saturation, Six-axis Saturation, Gamma.**
  - In the **MOBA Mode**, the following function(s) are not user-configuration: **Shadow Boost, VividPixel, Saturation, Six-axis Saturation.**
  - In the **Night Vision** mode, the following function(s) are not user-configuration: **Saturation, Six-axis Saturation.**
-

### 1.3.5 Other Function(s)

- HDR

The monitor supports HDR format. When detecting HDR content, an "HDR ON" message will pop up and display in the OSD menu.



- 
- When displaying HDR content, the following function(s) are not available: **ELMB, PIP/PBP, GameVisual, Shadow Boost, Contrast, Blue Light Filter, Color Temp., Gamma, Saturation, Power Saving, Display Color Space, Six-axis Saturation, Sniper, Sniper Night Vision, Proximity Sensor, Sound Source, Uniform Brightness.**
  - When HDR is enabled, to adjust the brightness, go to **Image > HDR Setting > Brightness Adjustable.**
-





## 2.1 Attaching the arm/base

To assemble the monitor base:

1. Open the box as illustrated. (Figure 1)
2. Insert the base into the arm. Fix the base to the arm by fastening the bundled screw. (Figure 2)
3. Attach the arm into the monitor. (Figure 3)
4. Hold the stand and lift the monitor carefully, then place it on a flat surface. (Figure 4)

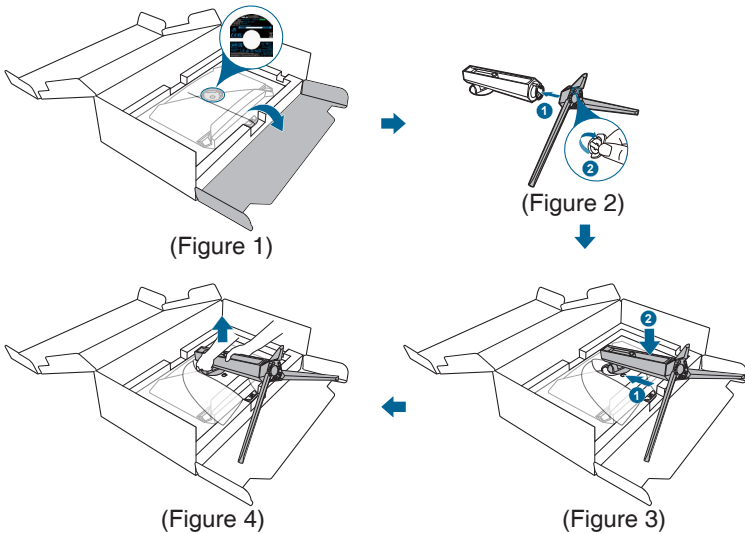

We recommend that you cover the table surface with soft cloth to prevent damage to the monitor.



Base screw size: M5 x 25 mm.

## 2.2 Cable management

You can organize the cables with the help of the cable management slot.

- **Arranging the cables**

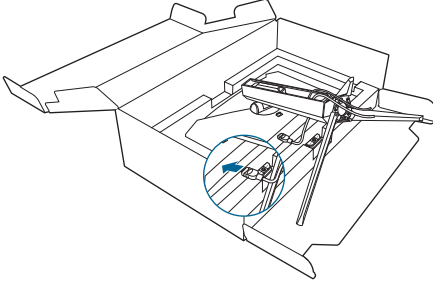

## 2.3 Detaching the arm/base (for VESA wall mount)

The detachable arm of this monitor is specially designed for VESA wall mount.

To detach the arm:

1. Press the release button, and then detach the arm/base from the monitor.
2. Attach the ROG wall mount kit to the back on the monitor.

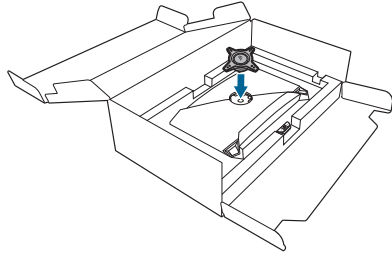
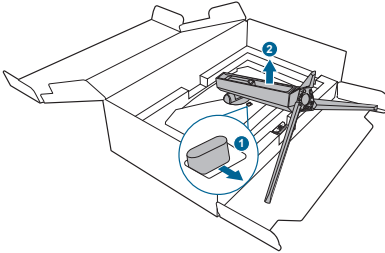

---

Handle with caution to avoid injury or damage to the monitor.

---



- The VESA wall mount kit (100 x 100 mm) is purchased separately.
  - Use only the UL Listed Wall Mount Bracket with minimum weight/load 22.7kg (Screw size: M4 x 10 mm).
-

## 2.4 Adjusting the monitor

- For optimal viewing, we recommend that you look at the full face of the monitor, then adjust the monitor to the angle that is most comfortable for you.
- Hold the stand to prevent the monitor from falling when you change its angle.
- You can adjust the monitor's angle from  $+20^{\circ}$  to  $-5^{\circ}$ , and it allows  $15^{\circ}$  swivel adjustment from either left or right. You can also adjust the monitor's height within 80 mm.

(Tilt)

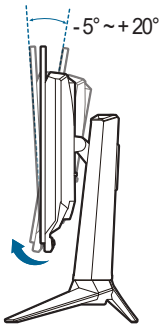

(Height adjustment)

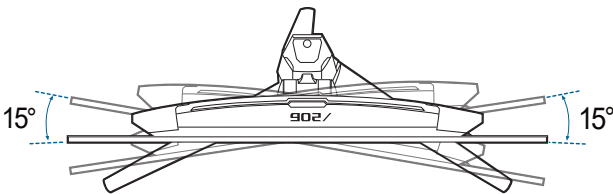
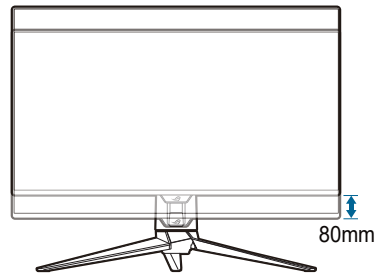

(Swivel)

## 2.5 Connecting the cables

Connect the cables as the following instructions:

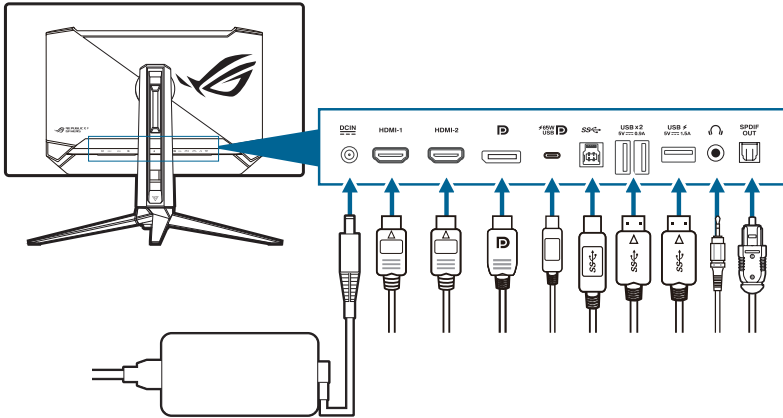

- **To connect the power cord:**
  - a. Connect the power adapter securely to the monitor's DC IN input.
  - b. Connect one end of the power cord to the power adapter and the other end to a power outlet.
- **To connect the HDMI/DisplayPort/USB Type-C cable:**
  - a. Plug one end of the HDMI/DisplayPort/USB Type-C cable to the monitor's HDMI/DisplayPort/USB Type-C jack.
  - b. Connect the other end of the HDMI/DisplayPort/USB Type-C cable to your device's HDMI/DisplayPort/USB Type-C jack.
- **To use the earphone:** connect the audio cable to the monitor's earphone jack.
- **To use the USB 3.2 Gen 1 ports:** Take the USB cable, and plug the smaller end (type B) of the USB upstream cable to the monitor's USB upstream port, and the larger end (type A) to your computer's USB port. Make sure your computer is installed with the latest Windows 10/Windows 11 operating system. That will enable the USB ports on the monitor to work.
- **To connect the S/PDIF Optical Digital audio cable:** Connect the speaker to the monitor's SPDIF out port.



When these cables are connected, you can choose the desired signal from the Input Select item in the OSD menu.



If you need to replace the power cord or the connection cable(s), please contact ASUS customer service.



---

The USB cable can be used for firmware update.

---



## 2.6 Turning on/off the monitor

- **To turn on the monitor:**

Press  Power button on the monitor. See page 1-2 for the location of the power button. If the **Power Indicator** function is enabled and an input source is detected, the power LED will light up red to indicate that the monitor is turned on. The power LED will not light up in **Power Saving Mode**. You can also press any button to turn on the monitor when the monitor is turned off.

- **To turn off the monitor:**

There are 2 ways to turn off the monitor:

- Press  Power button on the monitor twice.
- Press  Power button on the monitor. Use the navigation (5-way) button to select "Turn Off" and press the navigation (5-way) button to confirm.



---

If you need to disconnect power supply, unplug the power cord from the power outlet. Do not unplug the power adapter from the monitor.







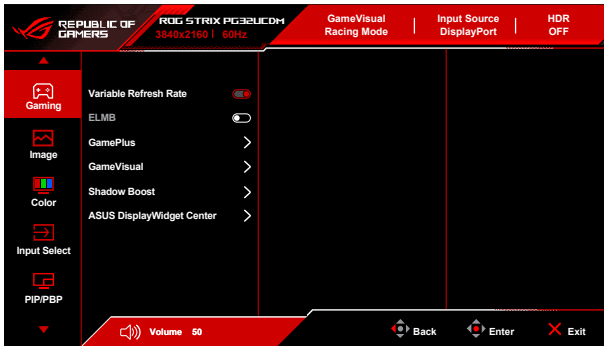

---



## 3.1 OSD (On-Screen Display) menu

### 3.1.1 How to reconfigure



1. After the monitor is turned on, press the  (5-way) button to activate the OSD menu.
2. Move the  (5-way) button up/down to navigate through the functions. Highlight the desired function and press the  (5-way) button to activate it. If the function selected has a sub-menu, move the  (5-way) button up/down again to navigate through the sub-menu functions. Highlight the desired sub-menu function and press the  (5-way) button or move the  (5-way) button right to activate it.
3. Move the  (5-way) button up/down to change the settings of the selected function.
4. To exit and save the OSD menu, press the  Close button or press the  (5-way) button until the OSD menu disappears. To adjust other functions, repeat steps 1-3.

### 3.1.2 OSD function introduction

#### 1. Gaming

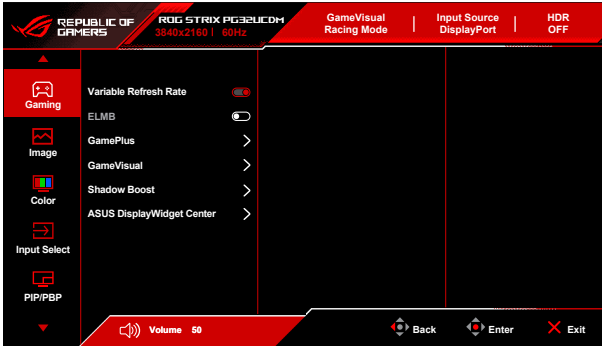

- **Variable Refresh Rate:** Allows an **Variable Refresh Rate** supported\* graphics source to dynamically adjust display refresh rate based on typical content frame rates for power efficient, virtually stutter free and low-latency display update.



The following function(s) will be disabled when this function turns on: **PIP/PBP, ELMB, Aspect Control.**

\***Variable Refresh Rate** can only be activated within 48Hz~240Hz.

\*For supported GPUs, minimum PC system and driver requirements, please contact the GPU manufactures.

- **ELMB:** Extreme Low Motion Blur.



This function is only available when the refresh rate is 120Hz.

When this function is activated, the following function(s) are not available: **Variable Refresh Rate, Blue Light Filter, Aspect Control, HDR, PIP/PBP, Uniform brightness.**

- **GamePlus:** See **1.3.3 GamePlus function** for details.
- **GameVisual:** See **1.3.4 GameVisual function** for details.



The following function(s) will be disabled when this function turns on: **HDR.**

- **Shadow Boost:** Dark color enhancement adjusts monitor gamma curve to enrich the dark tones in an image, making dark scenes and objects much easier to be seen.



This function is only available in **Scenery Mode, Racing Mode, Cinema Mode, RTS/RPG Mode, FPS Mode, Night Vision Mode** or **User Mode.**

- **ASUS DisplayWidget Center:** Displays a QR code for you to access the information about ASUS DisplayWidget Center.



## 2. Image



- **Brightness:** The adjusting range is from 0 to 100.
- **Uniform Brightness:** With the feature enabled, the system will not adjust the maximum brightness of the screen when the screen is displayed in a different screen size.
- **Contrast:** The adjusting range is from 0 to 100.
- **VividPixel:** This function enhances the outline of the displayed picture and generates high-quality images on screen.
- **HDR Setting** (High Dynamic Range Setting): Contains 4 HDR modes:
  - **Gaming HDR**
  - **Cinema HDR**
  - **Console HDR**
  - **DisplayHDR 400 True Black**
  - **Brightness Adjustable:** The HDR brightness can be adjusted when the **Brightness Adjustable** function is enabled. HDR PQ curve will be affected when the brightness adjustment is **ON** under HDR mode.



When displaying HDR content, the following function(s) are not available: **ELMB, PIP/PBP, GameVisual, Shadow Boost, Contrast, Blue Light Filter, Color Temp., Gamma, Saturation, Power Saving, Display Color Space, Six-axis Saturation, Sniper, Sniper Night Vision, Proximity Sensor, Sound Source, Uniform Brightness.**

- **Aspect Control:** Adjust the aspect ratio to **16:9** or **Square** to enjoy different gaming scenario.
  - **16:9:** Simply choose **Fill Up, 27" Simulation** or **24.5" Simulation** under **Full** for better FPS gaming size; or you can choose **Pixel by pixel** such as 3288 x 1850 resolution for 27" or 2992 x 1684 resolution for 24.5" under Windows Display setting.

- **Square:** Provides multiple aspect ratio choices with different screen sizes, including **Full**, **Equivalent** and **Pixel by pixel**.



---

The following function(s) will be disabled when this function turns on: **Variable Refresh Rate, PIP/PBP, ELMB**.

---

- **Blue Light Filter:**
  - **OFF:** No change.
  - **Level 1~4:** The higher the level, the less blue light is scattered. When Blue Light Filter is activated, the default settings of Racing Mode will be automatically imported. Between Level 1 to Level 3, the Brightness function is user-configurable. Level 4 is an optimized setting. The Brightness function is not user-configurable.



---

The monitor uses low blue light panel and compliance with TÜV Rheinland Low Blue Light Hardware Solution at factory reset/default setting mode (Brightness: 65%, Contrast: 80%, CCT: 6500K, Preset mode: Racing mode, Power Setting: YES).

---



---

The following function(s) will be disabled when this function turns on: **ELMB**.

---

- Please refer to the following to alleviate eye strains:
  - Users should take some time away from the display if working for long hours. It is advised to take short breaks (at least 5 mins) after around 1 hour of continuous working at the computer. Taking short and frequent breaks is more effective than a single longer break.
  - To minimize eye strain and dryness in your eyes, you should rest the eye periodically by focusing on objects that are far away.
  - Eye exercises can help to reduce eye strain. Repeat these exercises often. If eye strain continues please consult a physician. Eye exercises: (1) Repeating look up and down (2) Slowly roll your eyes (3) Move your eyes diagonal.
  - High energy blue light may lead to eye strain and AMD (Age-Related Macular Degeneration). Blue light Filter reduces 70% (max.) harmful blue light to avoid CVS (Computer Vision Syndrome).
-

### 3. Color

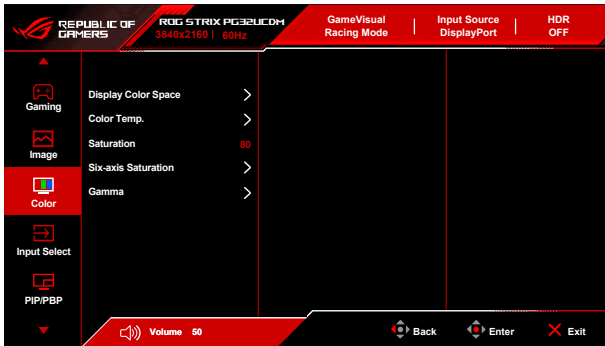

- **Display Color Space:** Selects the color space for the monitor color output.
- **Color Temp.:** Contains 8 modes including **4000K, 5000K, 6500K, 7500K, 8200K, 9300K, 10000K** and **User** mode.
- **Saturation:** The adjusting range is from 0 to 100.



This function is not available when **sRGB Cal Mode, MOBA Mode** or **Night Vision** is selected.

- **Six-axis Saturation:** Adjusts the saturation for R, G, B, C, M, Y.
- **Gamma:** Allows you to set the color mode to **1.8, 2.0, 2.2, 2.4** or **2.6**.

### 4. Input Select

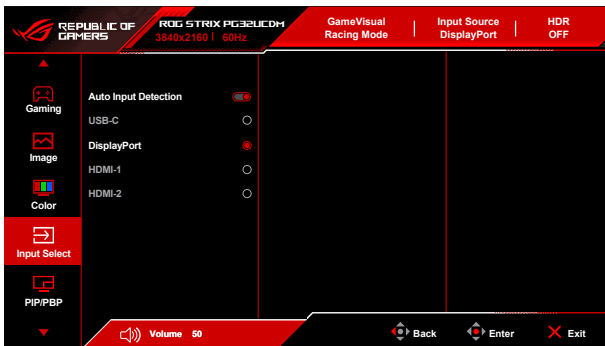

- **Auto Input Detection:** When enabled, the system will automatically select the latest inserted I/O port.
- **USB-C, DisplayPort, HDMI-1, HDMI-2:** Manually selects the input source.

## 5. PIP/BPB

The **PIP/BPB** allows you to open up sub-window(s) connected from any video source.



The following function(s) will be disabled when this function turns on: **Variable Refresh Rate, Aspect Control, ELMB, DSC Support.**

**PIP/BPB Mode** is used under 60Hz.

**PIP/BPB Mode** does not support HDR function.

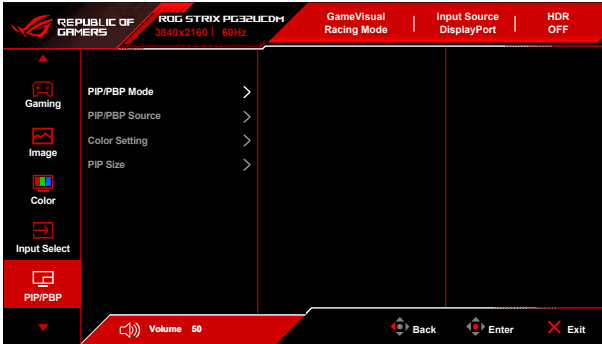

- **PIP/BPB Mode:** Selects PIP, BPB mode or turn it off.
- **PIP/BPB Source:** Select the video input source for each PIP/BPB window.
- **Color Setting:** Sets **GameVisual** mode for each PIP/BPB window.
- **PIP Size:** Adjusts the PIP size to **Small, Middle, or Large.**

## 6. Lighting Effect

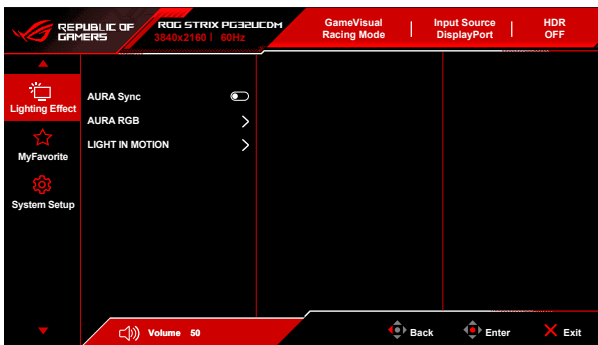

- **Aura Sync:** Allows you to turn on or off the Aura Sync function that synchronizes the Aura RGB light effect among all supported devices.



---

The following function(s) will be disabled when this function turns on: **Aura RGB**.

---

- **Aura RGB:** There are 5 living colors can be chosen: **OFF, Rainbow, Color Cycle, Static, Breathing, Strobing**. You can manually change the R/G/B/C/M/Y color for **Static, Breathing, and Strobing** modes.



---

This function is not available when **Aura Sync** is enabled.

---

- **LIGHT IN MOTION:** Selects the brightness level of the light on the stand. The adjusting range is from **“OFF”** to **“Level 3”**.

## 7. MyFavorite

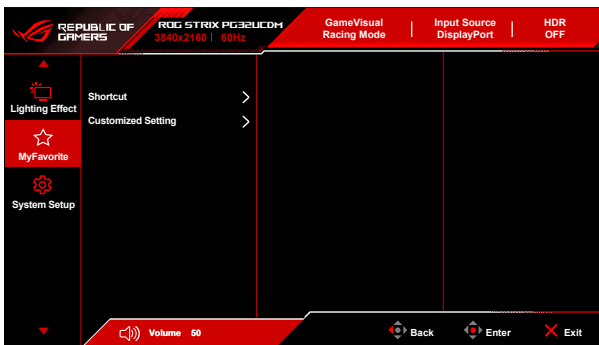

- **Shortcut:**
  - **Shortcut:** Sets the shortcut functions for shortcut buttons.



---

When a certain function is selected or activated, your shortcut button may not support. Available function choices: **GamePlus, GameVisual, Brightness, Mute, Shadow Boost, Contrast, Input Select, HDR setting, Blue Light Filter, Color Temp., Volume, Keyboard Hotkey, KVM, Pixel Cleaning, Customized Setting-1, Customized Setting-2**.

---

- **Customized Setting:**
  - **Setting 1/Setting 2:** Loads/Saves all settings on the monitor.

## 8. System Setup

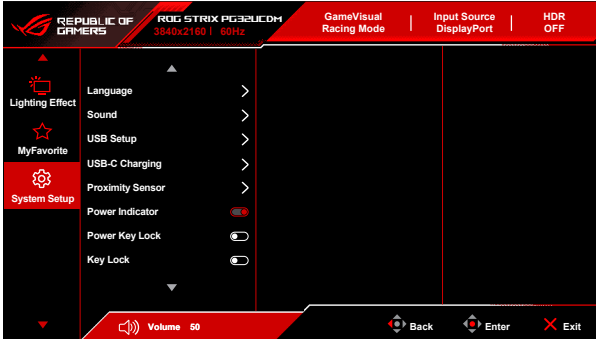

- **Language:** There are 23 languages for your selection, including English, French, German, Italian, Spanish, Dutch, Portuguese, Russian, Czech, Croatian, Polish, Romanian, Hungarian, Turkish, Simplified Chinese, Traditional Chinese, Japanese, Korean, Thai, Indonesian, Persian, Ukrainian, Vietnamese.
- **Sound:** Sets the sound related settings from this menu.
  - **Volume:** The adjusting range is from 0 to 100.
  - **Mute:** Toggles the monitor sound between on and off.
  - **Sound Source:** Decides the monitor sound comes from which source.
  - **Sound Output:** Set the sound output setting to **Line out** or **SPDIF**. When **SPDIF** is selected, **Volume** cannot be adjusted.
- **USB Setup:** Configures the USB port settings.

- **KVM:** Switches USB downstream port to USB Type-C or USB Type-B upstream port.

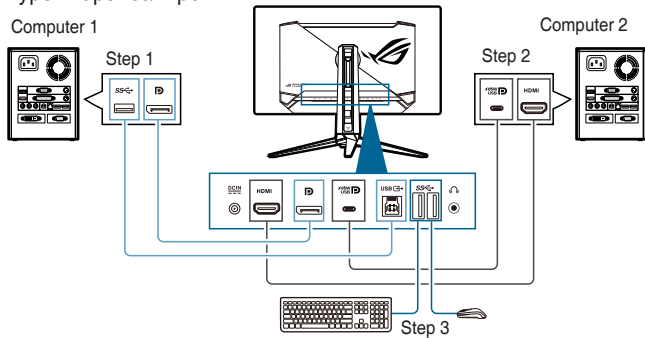

Or

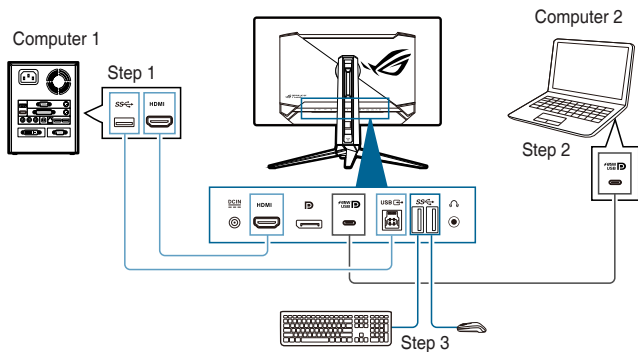

- **Type-C Bandwidth:** Select USB Type-C with **USB 2.0** or **USB 3.2**. **USB 3.2** is up to 3840 x 2160@144Hz when **DSC support** is **ON**.
- **USB Hub:** Set the USB Hub availability during standby mode.



This function is not available (set as **On During Standby**) when **Aura Sync** is enabled.

- **Keyboard Hotkey:** Enables the keyboard hotkeys. The definition for keyboard hotkeys are as below.
  - Keyboard Hotkey1 (CTRL+ALT+Q): KVM switch & PIP switch
  - Keyboard Hotkey2 (CTRL+ALT+W): Customize setting switch
  - Keyboard Hotkey3 (CTRL+ALT+E): Pixel cleaning
- This function is only available when your USB upstream port is connected and keyboard is connected to monitor's USB downstream port.



- When using Keyboard Hotkey 1, if your keyboard is locked, try the following key combinations to unlock it: Ctrl+num lock, or Alt+num lock .
  - Keyboard Hotkey 1 is only available when KVM and/or PIP function are activated.
- 

- **USB-C Charging:**

- **65 W:** The USB Type-C port provides 65W power supply.
- **90 W:** The USB Type-C port provides 90W power supply. The maximum brightness will be 65.

- **Proximity Sensor:** If the function is enabled and the system does not detect the presence of object within 50 cm - 110 m (depending on your selection) over the preset time, the system will automatically decrease brightness periodically.



- The detective range may be slightly different if user wears dark or bright colored clothing. Set the sensitivity to **High** when wearing black or other dark clothes.
  - If the function is enabled and no activity is detected, the monitor will gradually lower its brightness while displaying energy saving messages. The monitor resumes normal brightness once it detects human activity again. After a set period of time into power saving mode, the monitor will enter standby mode.
  - Please avoid placing objects in front of the sensor (between 50 cm and 110 cm), as it will cause the function of the sensor to fail (misjudging that someone is ahead).
- 

- **Power Indicator:** Turns the power LED indicator on/off.
  - **Power Key Lock:** Enables or disables the power key.
  - **Key Lock:** To disable all function keys. Move and hold the  (5-way) button downward for over 5 seconds to cancel the key lock function.
  - **Power Setting:**
    - **Standard Mode:** Standard mode setting may result in higher power consumption.
    - **Power Saving Mode:** Power saving mode may cause limited luminance performance.
- 



Certain functions that consumes power will be disabled when **Power Saving Mode** is selected. If you wish to enable the functions, choose **Standard Mode**.

---



Please turn off HDR function before activating the **Power Saving Mode**.

---

- **OSD Setup:**



- Adjusts the OSD position.
- Adjusts the OSD timeout from 10 to 120 seconds.
- Adjusts the OSD background from opaque to transparent.
- Enables or disables the DDC/CI function.
- **Screen Protection:** Configures the screen saver related set up. You can improve the image quality issues related to image retention when the screen is on for a certain amount of time.
  - **Screen Saver:** Enables/disables the screen saver function. The screen brightness will automatically decrease when there is no change on the screen.
  - **Pixel Cleaning:** It calibrates any issues that may arise on the screen when your monitor has been turned on for a long time. The process will take approximately 6 minutes. This function will automatically activate when the monitor is turned off. Do not unplug the power cord while it is in progress. If you power on the monitor, the **Pixel Cleaning** will stop operating.
  - **Pixel Cleaning Reminder:** Enable or disable displaying pixel cleaning reminder.
  - **Screen Move:** Select the screen movement level to prevent image sticking on the display panel.
  - **Auto Logo Brightness:** Enable this function to allow the system to automatically adjust the logo brightness to correct the potential picture quality issues.
- **DisplayPort Stream:** Compatibility with graphic card. Select **DisplayPort 1.2**, or **DisplayPort 1.4** by graphic card supported DP version.
- **DSC Support:** DisplayPort Display Stream Compression.
- **Color Calibraion:**
  - **Color Calibraion Report:** Views the color calibration report for this monitor.
- **Information:** Shows the monitor information.
- **All Reset:** Selecting “**Yes**” allows you to restore the default settings.

## 3.2 Aura

Armoury Crate is a software program that controls the colorful LEDs on supported devices, such as monitors, motherboards, graphic cards, desktop PCs, etc. Aura allows you to adjust the color of the RGB LEDs on these devices and select different light effects. You can also correct or adjust the color of the LEDs by calibrating them.

To activate Aura:

1. Turn ON the **Aura Sync** function in the OSD menu.
2. Connect the USB 3.2 Gen 1 upstream port of the monitor to the USB port of your computer.
3. Install Armoury Crate and then restart the computer.
4. Execute Armoury Crate.

Below is the overview of this program.

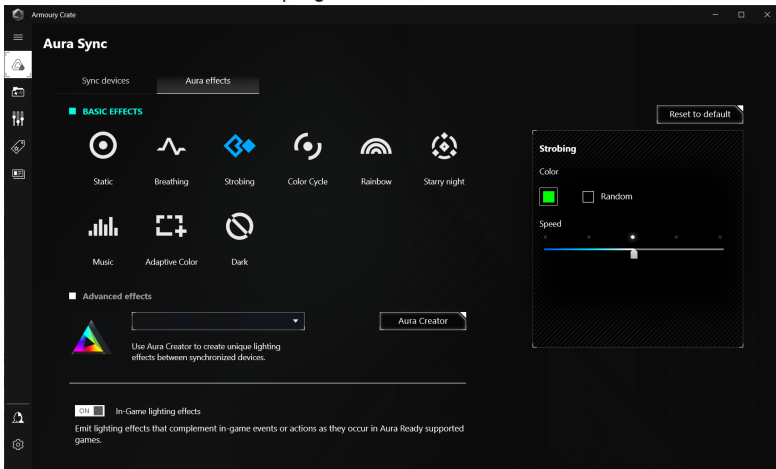

- If the USB upstream connection between the monitor and computer is disconnected, to resume the Aura function, you need to re-connect the USB 3.2 Gen 1 upstream port of the monitor to the computer and then restart the computer.
- Visit [https://rog.asus.com/innovation/armoury\\_crate/](https://rog.asus.com/innovation/armoury_crate/) for more details.

### 3.3 Specifications summary

<b>Panel Type</b>	OLED
<b>Panel size</b>	31.5" (16:9, 80.3 cm) wide screen
<b>Max. Resolution</b>	3840 x 2160
<b>Pixel pitch</b>	0.1814 mm x 0.1814 mm
<b>Brightness</b>	250 cd/m <sup>2</sup> , 1000 cd/m <sup>2</sup> (peak)
<b>Contrast Ratio (Typ.)</b>	1,500,000:1
<b>Viewing angle (H/V) CR&gt;10</b>	178°/178°
<b>Display colors</b>	1073.7 M (10 bit)
<b>Color gamut</b>	DCI-P3 99%
<b>Response time</b>	0.03 ms
<b>Color temperature selection</b>	8 color temperatures
<b>Digital input</b>	HDMI v2.1 x 2, DisplayPort v1.4 x 1, USB Type-C x 1
<b>Earphone jack</b>	Yes
<b>SPDIF out</b>	Yes
<b>Audio input</b>	No
<b>Speaker (Built-in)</b>	No
<b>USB 3.2 Gen 1 port</b>	1 x USB Type-C 1 x USB 3.2 Gen 1 Type-B 3 x USB 3.2 Gen 1 Type-A
<b>USB 2.0 port</b>	No
<b>Color</b>	Black
<b>Power LED</b>	Red (On)/Amber (Standby)/Orange flashing (Pixel cleaning)
<b>Tilt</b>	+20° ~ -5°
<b>Swivel</b>	+15° ~ -15°
<b>Pivot</b>	No
<b>Height Adjustment</b>	80 mm
<b>Kensington lock</b>	Yes
<b>Voltage rating</b>	AC: 100~240V DC: 20.0V --- 14.0A (AC adapter)
<b>Power consumption</b>	Power On: < 42 W** (Typ.), Standby: < 0.5 W, Power Off: < 0.3 W
<b>Temperature (Operating)</b>	0°C~40°C
<b>Temperature (Non-operating)</b>	-20°C~+60°C
<b>Dimension (W x H x D) without stand</b>	718 x 430 x 74 mm
<b>Dimension (W x H x D)</b>	718 x 579 x 274 mm (with stand, highest) 718 x 499 x 274 mm (with stand, lowest) 868 x 514 x 238 mm (package)
<b>Weight (Esti.)</b>	6 kg (without stand); 8.8 kg (Net); 15.2 kg (Gross)

<b>Multi-languages</b>	23 languages (English, French, German, Italian, Spanish, Dutch, Portuguese, Russian, Czech, Croatian, Polish, Romanian, Hungarian, Turkish, Simplified Chinese, Traditional Chinese, Japanese, Korean, Thai, Indonesian, Persian, Ukrainian, Vietnamese)
<b>Accessories</b>	Quick start guide, warranty card, power adapter, power cord, HDMI cable (optional), DisplayPort cable (optional), USB Type-A to Type-B cable (optional), USB Type-C cable (optional), ROG welcome card with envelope, ROG wall mount kit, ROG sticker, ROG pouch
<b>Compliance and Standards</b>	cTUVus, FCC, ICES-3, CB, CE, ErP, WEEE, EU Energy label , UkrSEPRO, Ukraine Energy, CU, CCC, China Energy Label, BSMI , RCM, MEPS, VCCI, PSE, PC Recycle , J-MOSS, KC, KCC, KMEPS, PSB, RoHs, CEC, Windows 10 & 11 WHQL, TUV Flicker free, TUV Low Blue Light

\*Specifications are subject to change without notice.

\*\*measuring a screen brightness of 200 nits without audio/USB/Card reader connection.



### 3.5 Troubleshooting (FAQ)

Problem	Possible Solution
Power LED is not ON	<ul style="list-style-type: none"> <li>• Press any button to check if the monitor is in the ON mode.</li> <li>• Check if the power cord is properly connected to the monitor and the power outlet.</li> <li>• Check if the power switch is ON.</li> </ul>
The power LED lights amber and there is no screen image	<ul style="list-style-type: none"> <li>• Check if the monitor and the computer are in the ON mode.</li> <li>• Make sure the signal cable is properly connected the monitor and the computer.</li> <li>• Inspect the signal cable and make sure none of the pins are bent.</li> <li>• Connect the computer with another available monitor to check if the computer is properly working.</li> </ul>
Screen image is too light or dark	<ul style="list-style-type: none"> <li>• Adjust the Contrast and Brightness settings via OSD.</li> </ul>
Screen image bounces or a wave pattern is present in the image	<ul style="list-style-type: none"> <li>• Make sure the signal cable is properly connected to the monitor and the computer.</li> <li>• Move electrical devices that may cause electrical interference.</li> </ul>
Screen image has color defects (white does not look white)	<ul style="list-style-type: none"> <li>• Inspect the signal cable and make sure that none of the pins are bent.</li> <li>• Perform All Reset via OSD.</li> <li>• Adjust the R/G/B color settings or select the Color Temperature via OSD.</li> </ul>
No sound or sound is low	<ul style="list-style-type: none"> <li>• Ensure that the HDMI/DisplayPort/USB Type-C cable is properly connected to the monitor and the computer.</li> <li>• Adjust the volume settings of both your monitor and HDMI/DisplayPort/USB Type-C device.</li> <li>• Ensure that the computer sound card driver is properly installed and activated.</li> </ul>
HDR content is not played properly	<ul style="list-style-type: none"> <li>• Make sure the input source supports HDR playback (with proper system settings and latest software).</li> <li>• Make sure the content is HDR encoded.</li> </ul>

## 3.6 Supported operating modes

- **Native timings**

Resolution frequency	Refresh rate
640 x 480	60/75Hz
720 x 480	60Hz
720 x 576	50Hz
800 x 600	60/75Hz
1024 x 768	60/75Hz
1280 x 720	50/60Hz
1280 x 960	60Hz
1280 x 1024	60Hz
1600 x 1200	60Hz
1920 x 1080	25/30/50/60/100/120/240Hz
2560 x 1440	60/120/240Hz
3840 x 2160	25/30/50/60/100/120/240Hz

- **For Square timings**

Resolution frequency	Refresh rate
640 x 480	60/75Hz
720 x 480	60Hz
720 x 576	50Hz
800 x 600	60/75Hz
1024 x 768	60/75/240Hz
1280 x 720	50/60Hz
1280 x 960	60/240Hz
1280 x 1024	60Hz
1440 x 1080	240Hz
1600 x 1200	60Hz
1728 x 1080	240Hz
1920 x 1080	25/30/50/60/100/120/240Hz
1920 x 1440	240Hz
2560 x 1440	60Hz (DisplayPort only)

Resolution frequency	Refresh rate
2560 x 1440	120/240Hz
3840 x 2160	25/30/50/60/100/120Hz

- **For 16:9 (24.5" Simulation) aspect control timings**

Resolution frequency	Refresh rate
640 x 480	60/75Hz
720 x 480	60Hz
720 x 576	50Hz
800 x 600	60/75Hz
1024 x 768	60/75Hz
1280 x 720	50/60Hz
1280 x 960	60Hz
1280 x 1024	60Hz
1600 x 1200	60Hz
1920 x 1080	25/30/50/60/100/120/240Hz
2560 x 1440	60Hz (DisplayPort only)
2560 x 1440	120/240Hz
3840 x 2160	25/30/50/60/100/120/240Hz
2992 x 1684	60/120/240Hz

- **For 16:9 (27" Simulation) aspect control timings**

Resolution frequency	Refresh rate
640 x 480	60/75Hz
720 x 480	60Hz
720 x 576	50Hz
800 x 600	60/75Hz
1024 x 768	60/75Hz
1280 x 720	50/60Hz
1280 x 960	60Hz
1280 x 1024	60Hz
1600 x 1200	60Hz
1920 x 1080	25/30/50/60/100/120/240Hz



Resolution frequency	Refresh rate
2560 x 1440	60Hz (DisplayPort only)
2560 x 1440	120/240Hz
3840 x 2160	24/25/30/50/60/100/120/240Hz
3288 x 1850	60/120/240Hz

- **For 16:9 (Pixel by pixel) aspect control timings**

Resolution frequency	Refresh rate
640 x 480	60/75Hz
720 x 400	70Hz
720 x 480	60Hz
720 x 576	50Hz
800 x 600	60/75Hz
1024 x 768	60/75Hz
1280 x 720	50/60Hz
1280 x 960	60Hz
1280 x 1024	60Hz
1600 x 1200	60Hz
1920 x 1080	25/30/50/60/100/120/240Hz
2560 x 1440	60Hz (DisplayPort only)
2560 x 1440	120/240Hz
3840 x 2160	25/30/50/60/100/120/240Hz
2992 x 1684	240Hz
3288 x 1850	60/240Hz

- **For PBP timings**

Resolution frequency	Refresh rate
640 x 480	60Hz
720 x 480	60Hz
720 x 576	50Hz
800 x 600	60Hz
1024 x 768	60Hz
1280 x 720	50/60Hz

Resolution frequency	Refresh rate
1280 x 960	60Hz
1280 x 1024	60Hz
1600 x 1200	60Hz
1920 x 1080	25/30/50/60Hz
1920 x 2160	60Hz
2560 x 1440	60Hz
3840 x 2160	25/30/50/60Hz

- **For PIP timings**

Resolution frequency	Refresh rate
640 x 480	60Hz
720 x 480	60Hz
720 x 576	50Hz
800 x 600	60Hz
1024 x 768	60Hz
1280 x 720	50/60Hz
1280 x 960	60Hz
1280 x 1024	60Hz
1600 x 1200	60Hz
1920 x 1080	25/30/50/60Hz
2560 x 1440	60Hz
3840 x 2160	25/30/50/60Hz



CE FC

